

SEAMLESS PIPE BENDS 11 DEGREE SDR17

#PS243411

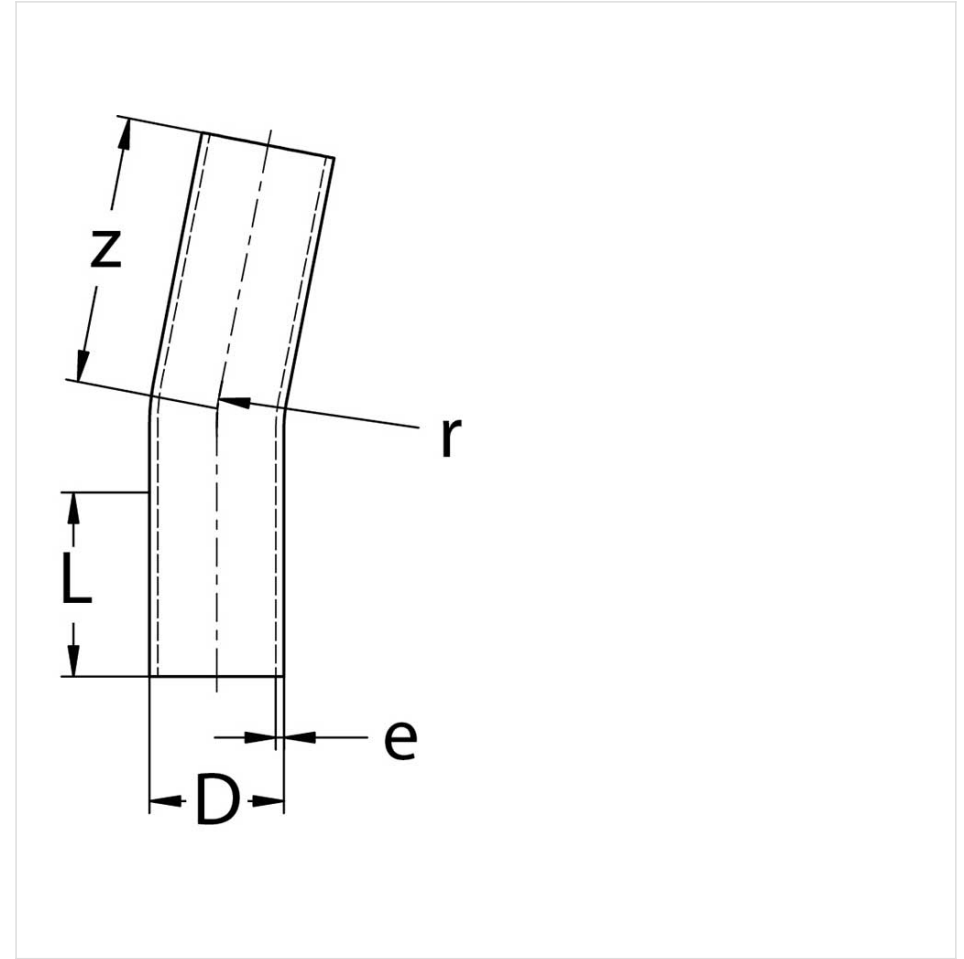

Body Material: PE100

Family Products

Product Code	R	D _{mm}	e _{mm}	L	z	Gas Pressure Rating	Suitable Pipes	Weight _{kg}
PS2434111125	95	63	3.8	100	160	PE100 SDR17	SDR17	0.20
PS2434121125	113	75	4.5	100	170	PE100 SDR17	SDR17	0.30
PS2434131125	135	90	5.4	360	373	PE100 SDR17	SDR17	1.10
PS2434141125	165	110	6.6	355	371	PE100 SDR17	SDR17	1.70
PS2434151125	188	125	7.4	355	373	PE100 SDR17	SDR17	2.10
PS2434161125	210	140	8.3	415	435	PE100 SDR17	SDR17	3.10
PS2434171125	240	160	9.5	410	433	PE100 SDR17	SDR17	4.00
PS2434181125	270	180	10.7	470	496	PE100 SDR17	SDR17	5.80
PS2434191125	300	200	11.9	465	494	PE100 SDR17	SDR17	7.20
PS2434201125	338	225	13.4	465	498	PE100 SDR17	SDR17	10.20
PS2434211125	375	250	14.8	525	561	PE100 SDR17	SDR17	12.50
PS2434221125	420	280	16.6	520	560	PE100 SDR17	SDR17	15.70
PS2434231125	470	315	18.7	580	625	PE100 SDR17	SDR17	22.10

Product Code	R	D _{mm}	e _{mm}	L	z	Gas Pressure Rating	Suitable Pipes	Weight _{kg}
PS2434241125	530	355	21.1	635	686	PE100 SDR17	SDR17	32.90
PS2434251125	637	400	23.7	300	650	PE100 SDR17	SDR17	34.90
PS2434261125	711	450	26.7	300	700	PE100 SDR17	SDR17	47.70
PS2434271125	783	500	29.7	300	750	PE100 SDR17	SDR17	63.20
PS2434281125	877	560	33.2	350	800	PE100 SDR17	SDR17	84.30
PS2434291125	955	630	37.4	350	850	PE100 SDR17	SDR17	113.60
PS2434301125	1128	710	42.1	350	1150	PE100 SDR17	SDR17	194.90
PS2434311125	1274	800	47.4	350	1250	PE100 SDR17	SDR17	268.80
PS2434321125	1430	900	53.3	400	1350	PE100 SDR17	SDR17	367.30