

SEAMLESS PIPE BENDS 11 DEGREE SDR11

#PS243311

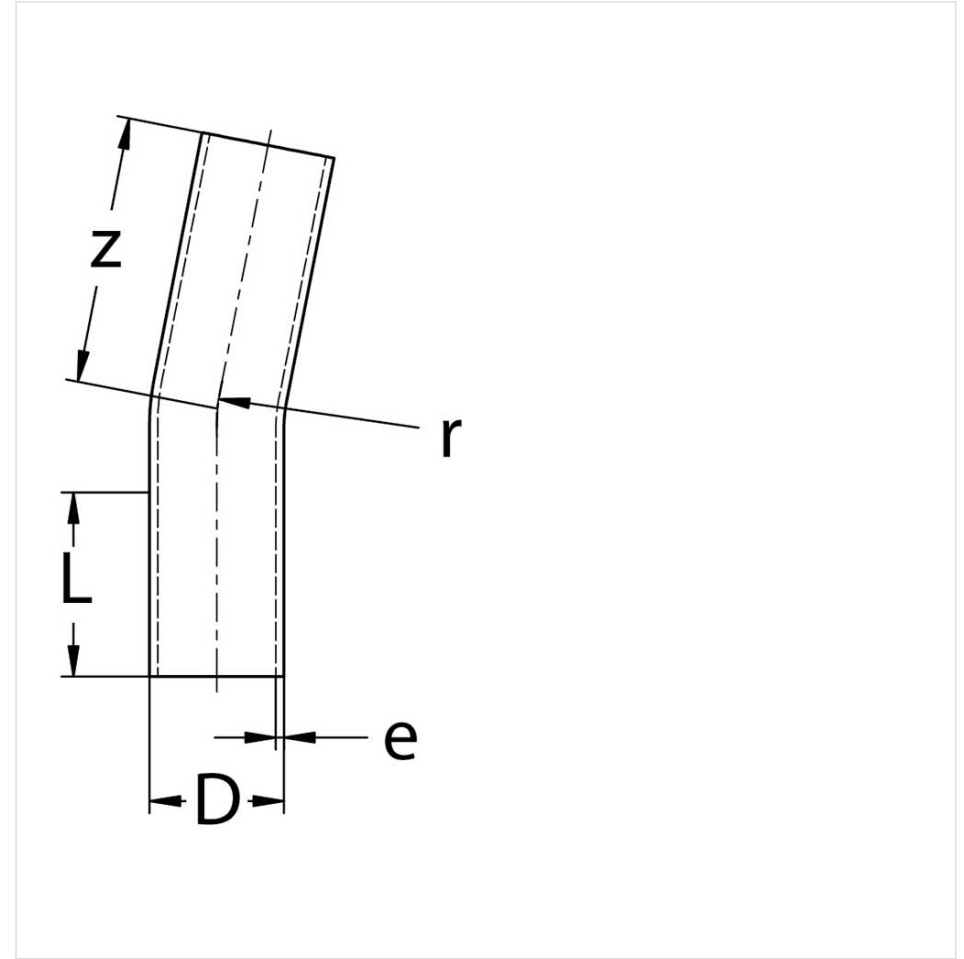

Body Material: PE100

Family Products

Product Code	R	D _{mm}	e _{mm}	L	z	Gas Pressure Rating	Suitable Pipes	Weight _{kg}
PS2433111125	95	63	5.8	100	160	PE100 SDR11	SDR11	0.30
PS2433121125	113	75	6.9	100	170	PE100 SDR11	SDR11	0.50
PS2433131125	135	90	8.2	360	373	PE100 SDR11	SDR11	1.60
PS2433141125	165	110	10.0	355	371	PE100 SDR11	SDR11	2.40
PS2433151125	188	125	11.4	355	373	PE100 SDR11	SDR11	3.10
PS2433161125	210	140	12.7	415	435	PE100 SDR11	SDR11	4.50
PS2433171125	240	160	14.6	410	433	PE100 SDR11	SDR11	5.90
PS2433181125	270	180	16.4	470	496	PE100 SDR11	SDR11	8.60
PS2433191125	300	200	18.2	465	494	PE100 SDR11	SDR11	10.60
PS2433201125	338	225	20.5	465	498	PE100 SDR11	SDR11	15.00
PS2433211125	375	250	22.7	525	561	PE100 SDR11	SDR11	18.40
PS2433221125	420	280	25.4	520	560	PE100 SDR11	SDR11	23.20
PS2433231125	470	315	28.6	580	625	PE100 SDR11	SDR11	32.50

Product Code	R	D_{mm}	e_{mm}	L	z	Gas Pressure Rating	Suitable Pipes	Weight_{kg}
PS2433241125	530	355	32.2	635	686	PE100 SDR11	SDR11	45.40
PS2433251125	637	400	36.3	300	650	PE100 SDR11	SDR11	51.70
PS2433261125	711	450	40.9	300	700	PE100 SDR11	SDR11	70.60
PS2433271125	783	500	45.4	300	750	PE100 SDR11	SDR11	93.30
PS2433281125	877	560	50.8	350	800	PE100 SDR11	SDR11	124.70
PS2433291125	955	630	57.2	350	850	PE100 SDR11	SDR11	167.90
PS2433301125	1128	710	64.5	350	1150	PE100 SDR11	SDR11	288.60
PS2433311125	1274	800	72.6	350	1250	PE100 SDR11	SDR11	397.90
PS2433321125	1430	900	81.7	400	1350	PE100 SDR11	SDR11	544.10